

# XS4P18AB110

Inductive proximity sensors XS, inductive sensor XS4 M18, L41mm, PBT, Sn8mm, 24...48 VDC, cable 2 m



## Main

Range of product	Telemecanique Inductive proximity sensors XS
Series name	Application
Sensor type	Inductive proximity sensor
Electrical circuit type	Analog output
Sensor name	XS4
Sensor design	Cylindrical M18
Size	41 mm
Body type	Fixed
Detector flush mounting acceptance	Non flush mountable
Material	Plastic
Type of output signal	Analogue
Wiring technique	3-wire
[Sn] nominal sensing distance	8 mm
Output circuit type	DC
Analogue output range	0...10 V
Electrical connection	Cable
Cable length	2 m
[Us] rated supply voltage	24...48 V DC
IP degree of protection	IP67 conforming to IEC 60529

## Complementary

Thread type	M18 x 1
Detection face	Frontal
Front material	PPS
Enclosure material	PBT

Operating zone	0.8...8 mm
Repeat accuracy	<= 3% of Sr
Linearity error	+/- 2 mA
Cable composition	3 x 0.34 mm <sup>2</sup>
Wire insulation material	PvR
Supply voltage limits	15...58 V DC
Switching frequency	<= 500 Hz
Current consumption	4 mA no-load
Maximum output current drift	10 %
Marking	CE
Threaded length	26 mm
Height	18 mm
Length	41 mm
Net weight	0.08 kg

## Environment

Product certifications	UL CCC CSA
Ambient air temperature for operation	-25...70 °C

## Packing Units

Unit Type of Package 1	PCE
Number of Units in Package 1	1
Package 1 Weight	81 g
Package 1 Height	13.2 cm
Package 1 width	9.5 cm
Package 1 Length	4.1 cm
Unit Type of Package 2	BAG
Number of Units in Package 2	1
Package 2 Weight	97 g
Package 2 Height	3 cm
Package 2 width	20 cm
Package 2 Length	15 cm
Unit Type of Package 3	S03
Number of Units in Package 3	44
Package 3 Weight	4.75 kg
Package 3 Height	30 cm
Package 3 width	30 cm
Package 3 Length	40 cm

## Offer Sustainability

Sustainable offer status	Green Premium product
REACH Regulation	<a href="#">REACH Declaration</a>
EU RoHS Directive	Pro-active compliance (Product out of EU RoHS legal scope) <a href="#">EU RoHS Declaration</a>
Mercury free	Yes
RoHS exemption information	<a href="#">Yes</a>
Environmental Disclosure	<a href="#">Product Environmental Profile</a>
Circularity Profile	<a href="#">End of Life Information</a>
California proposition 65	WARNING: This product can expose you to chemicals including: Diisononyl phthalate (DINP), which is known to the State of California to cause cancer, and Di-isodecyl phthalate (DIDP), which is known to the State of California to cause birth defects or other reproductive harm. For more information go to <a href="http://www.P65Warnings.ca.gov">www.P65Warnings.ca.gov</a>

Contractual warranty

---

Warranty	18 months
----------	-----------

---

Dimensions

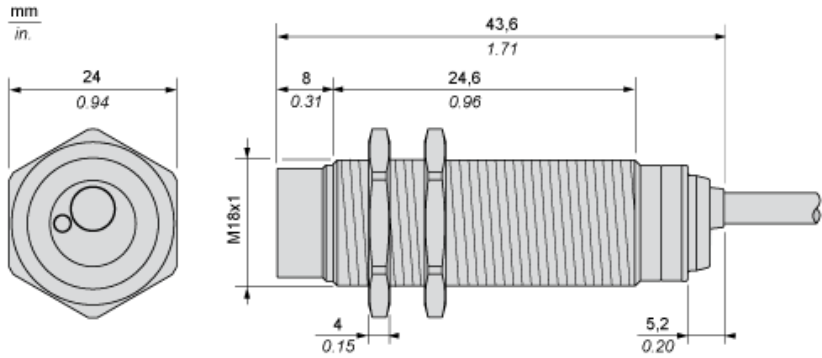

---

Minimum Mounting Distances

---

Side by side

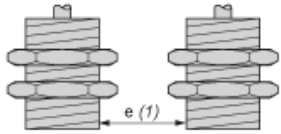

$e (1) \geq 32 \text{ mm}/1.26 \text{ in.}$

Face to face

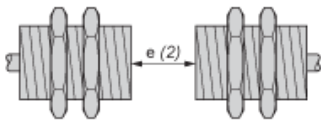

$e (2) \geq 96 \text{ mm}/3.78 \text{ in.}$

Facing a metal object

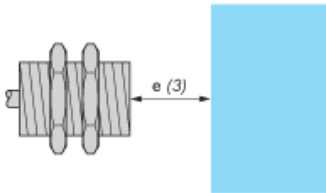

$e (3) \geq 24 \text{ mm}/0.94 \text{ in.}$

Mounted in a metal support

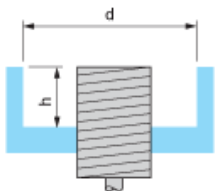

$d \geq 56 \text{ mm}/2.20 \text{ in.}$   
 $h \geq 16 \text{ mm}/0.63 \text{ in.}$

Mounting

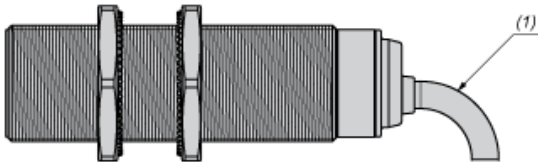

(1) Bending cable: 4 x external cable diameter

Wiring Schemes

3-Wire connection

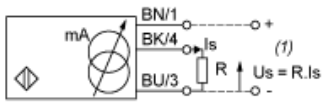

(1) Voltage output

BN : Brown

BK : Black

BU : Blue

	Output current	Load impedance value	Output voltage	Load impedance value
24 V	0...10 mA	$R \leq 1500 \Omega$	0...10 V	$R = 1000 \Omega$
48 V	0...10 mA	$R \leq 3300 \Omega$	0...10 V	$R = 1000 \Omega$

Output Curves

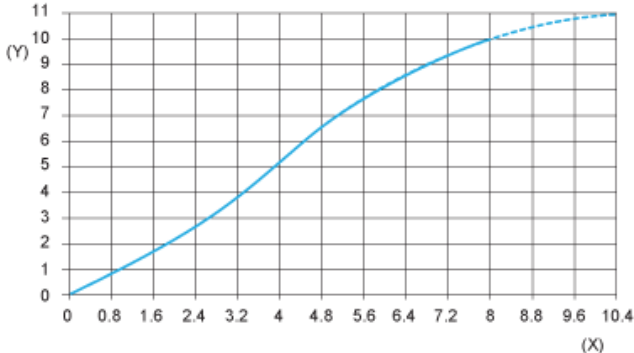

(Y) Is (V)  
(X) Sensors - object distance (mm)