

Product description	M9 IP67 male panel mount connector, Contacts: 2, unshielded, solder, IP67, front mounting
Area	M9 IP67 series 712
Order number	09 0403 80 02

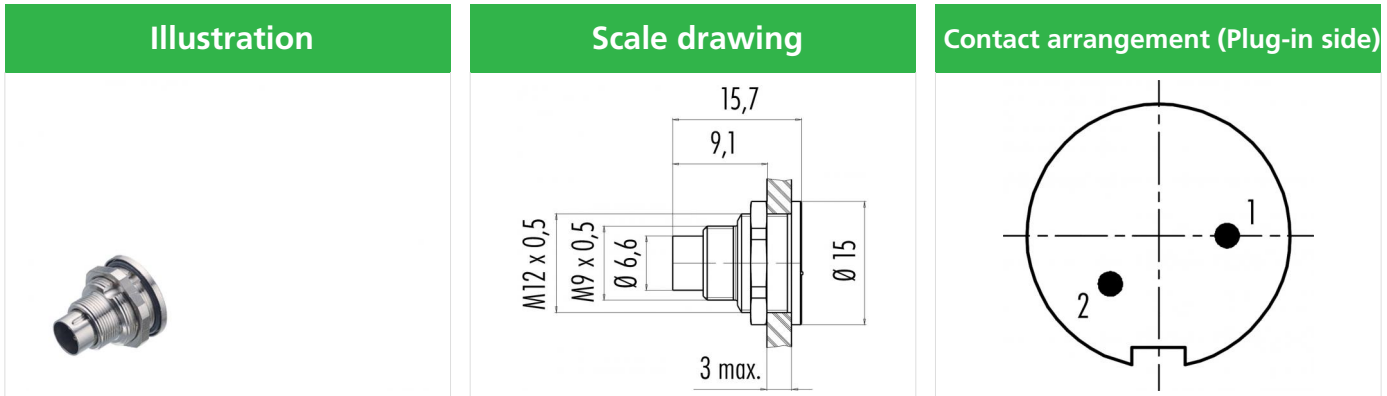

You can find the assembly instructions on the next page.

Technical data

General features

Order number	09 0403 80 02
Connector design	male panel mount connector
Version	connector male straight
Connector locking system	screw
Termination	solder
Degree of protection	IP67
Cross-sectional area	0.25 mm ² / AWG 24
Temperature range from/to	-40 °C / 85 °C
Mechanical operation	> 500 Mating cycles
Weight (g)	5.4
Customs tariff number	85369010

Material

Housing material	CuZn (Brass nickel plated)
Contact body material	PA (UL94 V-0)
Contact material	CuZn (brass)
Contact plating	Au (gold)
REACH SVHC	CAS 7439-92-1 (Lead)

Classifications

eCl@ss 11.1	27-44-01-09
ETIM 7.0	EC003569

Electrical parameters

Rated voltage	125 V
Rated impulse voltage	1500 V
Rated current (40 °C)	4 A
Insulation resistance	≥ 10 ¹⁰ Ω
Pollution degree	1
Overvoltage category	II
Insulating material group	III
EMC compliance	unshielded

Product description	M9 IP67 male panel mount connector, Contacts: 2, unshielded, solder, IP67, front mounting
Area	M9 IP67 series 712
Order number	09 0403 80 02

Assembly instructions / Panel cut-out



Product description **M9 IP67 male panel mount connector, Contacts: 2, unshielded, solder, IP67, front mounting**

Area **M9 IP67 series 712**
Order number **09 0403 80 02**

Security notices

The connector must not be plugged or unplugged under load. Non-observance and improper use can result in personal injury.

The connectors have been developed for applications in plant engineering, control and electrical equipment construction. The user is responsible for checking whether the connectors can also be used in other areas of application.

Plug connectors with enclosure protection IP 67 and IP 68 are not suitable for use under water. When used outdoors, the plug connectors must be protected separately against corrosion. For further information on the IP protection classes, please refer to the "Technical Information" download centre.