

Product description	M16 IP67 square male panel mount connector, Contacts: 4, unshielded, crimp (Crimp contacts must be ordered separately), IP67, UL
Area	M16 IP67 series 723
Order number	09 0111 370 04

Illustration

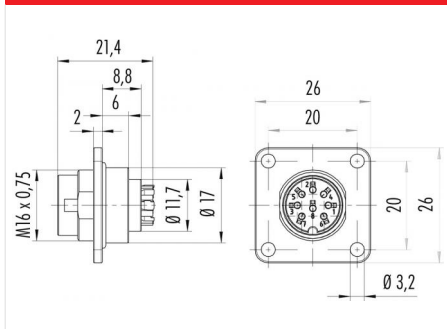

Scale drawing



Contact arrangement (Plug-in side)

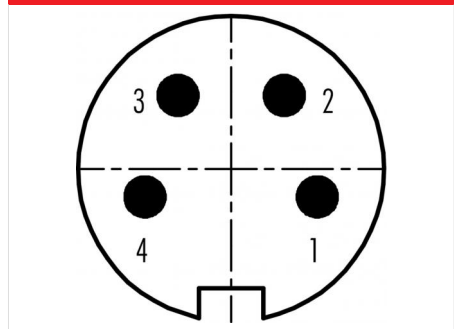

You can find the assembly instructions on the next page.

Technical data

General features

Order number	09 0111 370 04
Connector design	square male panel mount connector
Version	connector male straight screw
Connector locking system	crimp (Crimp contacts must be ordered separately)
Termination	IP67
Degree of protection	see crimp contacts under accessories
Cross-sectional area	-40 °C / 100 °C
Temperature range from/to	> 500 Mating cycles
Mechanical operation	12.222
Weight (g)	85369010
Customs tariff number	

Material

Housing material	Zinc die-cast nickel-plated
Contact body material	PBT (UL94 V-0)
Contact material	depending on crimp contact (accessory)
Locking material	Zinc die-cast nickel-plated

Authorization/approvals

Approval 1	UL
------------	----

Electrical parameters

Rated voltage	250 V
Rated impulse voltage	1500 V
Rated current (40 °C)	5 A
Insulation resistance	≥ 10 ¹⁰ Ω
Pollution degree	1
Overvoltage category	I
Insulating material group	III
EMC compliance	unshielded

Product description	M16 IP67 square male panel mount connector, Contacts: 4, unshielded, crimp (Crimp contacts must be ordered separately), IP67, UL
Area	M16 IP67 series 723
Order number	09 0111 370 04

Assembly instructions / Panel cut-out

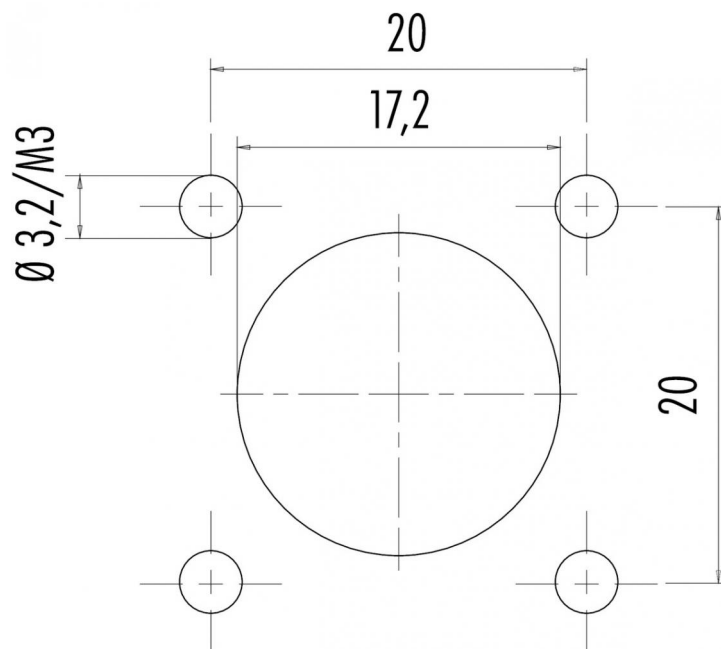

Product description	M16 IP67 square male panel mount connector, Contacts: 4, unshielded, crimp (Crimp contacts must be ordered separately), IP67, UL
Area	M16 IP67 series 723
Order number	09 0111 370 04

Security notices

The connector must not be plugged or unplugged under load. Non-observance and improper use can result in personal injury.

The connectors have been developed for applications in plant engineering, control and electrical equipment construction. The user is responsible for checking whether the connectors can also be used in other areas of application.

Plug connectors with enclosure protection IP 67 and IP 68 are not suitable for use under water. When used outdoors, the plug connectors must be protected separately against corrosion. For further information on the IP protection classes, please refer to the "Technical Information" download centre. The plug connector is not suitable for mains voltages. Please observe the pollution degree and the overvoltage category. For further information, please refer to the download center "Technical Information".

The protection class specification applies on condition that the four mounting holes are made as blind holes.